

Single Pitch Attachments

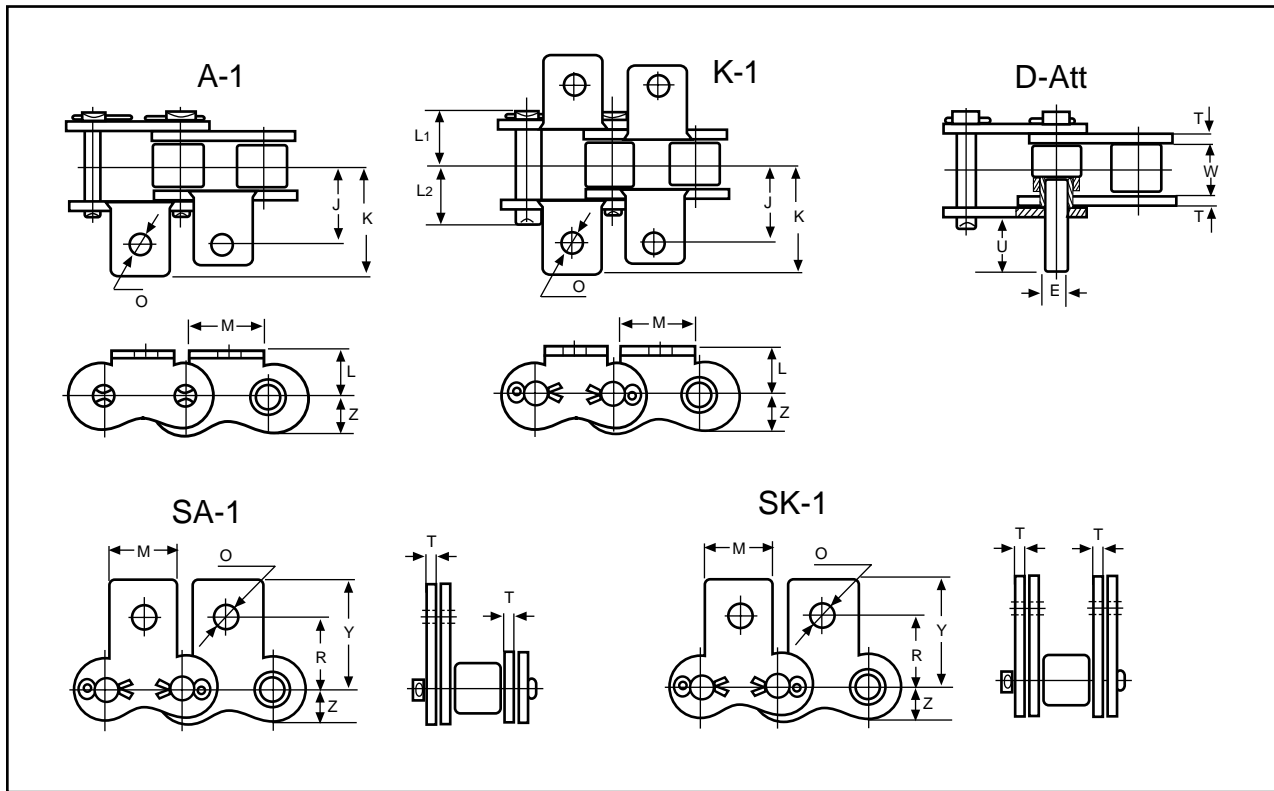

HKK Chain No.	Chain Pitch	J	K	L	M	O	Z	R	Y	E	U
HKK 35	3/8	0.375	0.562	0.250	0.312	0.134	0.174	0.375	0.578	0.141	0.375
HKK 40	1/2	0.500	0.679	0.312	0.375	0.142	0.279	0.500	0.734	0.156	0.375
HKK 50	5/8	0.625	0.917	0.406	0.500	0.205	0.286	0.625	0.906	0.200	0.468
HKK 60	3/4	0.750	1.106	0.468	0.625	0.205	0.343	0.720	1.062	0.234	0.562
HKK 80	1	1.000	1.413	0.625	0.750	0.268	0.457	0.968	1.359	0.312	0.750
HKK 100	1-1/4	1.250	1.742	0.781	1.000	0.346	0.571	1.250	1.703	0.375	0.937
HKK 120	1-1/2	1.500	2.154	0.906	1.125	0.413	0.670	1.437	2.031	0.437	1.125
HKK 140	1-3/4	1.750	2.485	1.125	1.375	0.472	0.805	1.750	2.484	0.500	1.312
HKK 160	2	2.000	2.828	1.250	1.500	0.551	0.919	2.000	2.734	0.562	1.500

Dimensions in inches & pounds

HKK Chain No.	Chain Pitch	T	W	H	L1	L2	Average Weight Per Attachment (lbs)				
							A att	K att	SA att	SK att	D att
HKK 35	3/8	0.050	3/16	0.347	0.233	0.267	0.002	0.004	0.002	0.004	0.002
HKK 40	1/2	0.060	5/16	0.457	0.323	0.354	0.003	0.006	0.003	0.006	0.002
HKK 50	5/8	0.080	3/8	0.571	0.400	0.445	0.009	0.018	0.009	0.018	0.004
HKK 60	3/4	0.094	1/2	0.689	0.500	0.548	0.014	0.028	0.014	0.028	0.005
HKK 80	1	0.125	5/8	0.921	0.628	0.750	0.030	0.060	0.030	0.060	0.024
HKK 100	1-1/4	0.156	3/4	1.154	0.772	0.913	0.059	0.118	0.059	0.118	0.030
HKK 120	1-1/2	0.187	1	1.382	0.971	1.124	0.105	0.210	0.105	0.210	0.050
HKK 140	1-3/4	0.219	1	1.610	1.060	1.228	0.144	0.288	0.144	0.288	0.070
HKK 160	2	0.250	1-1/4	1.839	1.262	1.435	0.195	0.390	0.195	0.390	0.100

Dimensions in inches & pounds

**QUICK
REFERENCE
GUIDE**

- Solid Roller ➤ Solid Bushing ➤ Custom Spacing ➤ Stainless Steel
- Nickel Plated ➤ British Standard ➤ Aqua-Series

HKK attachment chains are standard ANSI single and double pitch chains with modified side plates or pins. Attachments may be used for a variety of purposes such as conveying, timing, or alignment. Several types of standard attachments are available from stock while custom attachments can be made to order. HKK carbon steel attachment chains are standard with solid rollers and solid bushings, greatly extending chain life. For corrosive or extreme environments, stainless steel, nickel plated, and Aqua-Series chains are also available. HKK stocks many unique attachments for specialized applications such as the poultry, packaging, and forestry industries.

ATTACHMENT SPACING

When referencing attachment chains, the attachment spacing must be specified. The attachment spacing or centers (space from the center of one attachment to the next) should be referred to in terms of pitches (links). When counting pitches both the outside (pin link) and the inside (roller link) must be counted. Example: Attachments on Every Link (all inside and outside links). Attachments on every second pitch on the pin link (every outside link). Attachments on every second pitch on the roller link (every inside link). Attachment every third pitch (alternating between inside and outside links).

EVERY PITCH

Attachment on both inside and outside links.

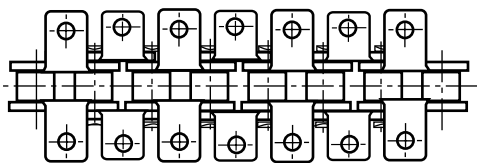

EVERY 3rd PITCH

Attachment alternating on inside and outside.

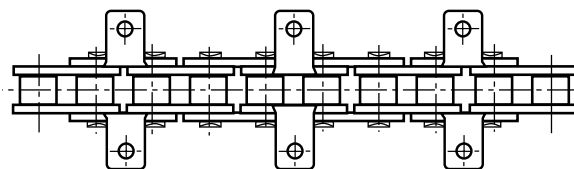

EVERY 2nd Pitch on PIN LINK

Attachment on every outside link.

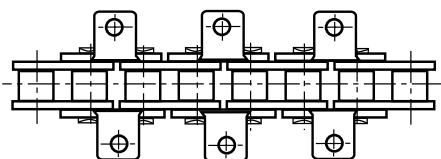

EVERY 4th Pitch on PIN LINK

Attachment on every other outside link.

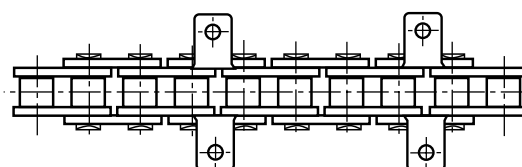

EVERY 2nd Pitch on ROLLER LINK

Attachment on every inside link.

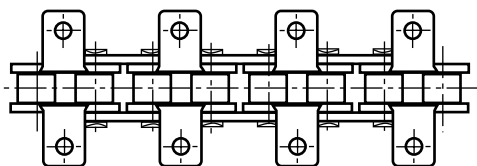

EVERY 4th Pitch on ROLLER LINK

Attachment on every other inside link.

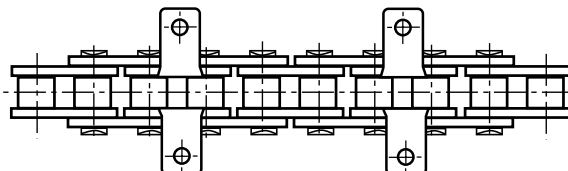

HKK Chain stocks most standard attachment chains in carbon steel and stainless steel. Most custom attachment spacing can be assembled with short delivery times. Single pitch chain with two attachment holes in one attachment is considered wide contour. Many custom attachments are also available or can be made to order, (see page 23.)

HKK (new)	HKK (old)	Dodge, Diamond, Morse	Rex, Link Belt
A-1	A-1	B-1, 1 hole	A-1
K-1	K-1	B-2, 1 hole	K-1
A-2	A-2	B-1, 2 hole	A-2
K-2	K-2	B-2, 2 hole	K-2
SA-1	M-1	S-1, 1 hole	M-35
SK-1	MM-1	S-2, 1 hole	M-1
SA-2	M-2	S-1, 2 hole	M-35-2
SK-2	MM-2	S-2, 2 hole	M-2
D-1	D-1	D-1	D-1
D-3	D-3	D-3	D-3

Single Pitch

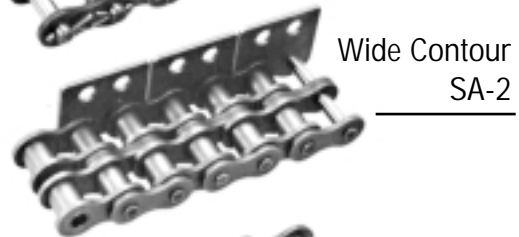

Double Pitch

